



Self-administration Guide



Real RUCONEST Patients,
Zack, Amy, Corey, Aaron, Peggy, and Mike



Your RUCONEST[®] Guide

(C1 esterase inhibitor [recombinant])

Welcome to RUCONEST! This step-by-step self-administration guide is designed to help you treat your HAE attacks with RUCONEST. You also have your RUCONEST Patient Advocate (RPA) nurse who is available to train you. Once you are fully trained and after preparing the medication, it will take 5 minutes for IV injection.

RUCONEST is an injectable medicine that is used to treat acute angioedema attacks in adult and adolescent patients over the age of 12 with Hereditary Angioedema (HAE). With appropriate training, you will be able to self-administer RUCONEST.

HAE is caused by a problem with a protein in the blood that helps control inflammation (swelling). This protein is called C1 esterase inhibitor (C1-INH) and for most HAE patients, there is either not enough of this protein, or it isn't working properly. RUCONEST addresses the root cause of HAE by replacing the missing C1-INH your body needs to help stop an HAE attack.

RUCONEST is an IV Injection (over 5 minutes) and can be administered using a simple butterfly needle attached to a syringe. This guide focuses on helping you find a vein. Should you have questions about administering RUCONEST through a port, your healthcare professional (HCP) or RPA can walk you through appropriate techniques to access and de-access your port. However, the steps included in this guide to reconstitute RUCONEST could be helpful for you.

We hope this step-by-step guide, along with the training support that is available to you, will be helpful as you start RUCONEST. If you have any questions or if you are unsure how to reconstitute and administer RUCONEST, ask your doctor or RPA.

RUCONEST SOLUTIONS[™] and your RPA nurse can provide additional HAE education and training to assist you in your treatment. [Click here](#) to learn more about available patient support.

Please click to the right to watch a video with step-by-step instructions on the reconstitution and administration of RUCONEST.



Gather your supplies

You and/or your caregiver can use this simple list of items used when administering RUCONEST. Each vial of RUCONEST will be provided in a single box. Depending upon your prescribed dose, you may use 1 or 2 vials. Check that your specialty pharmacy has sent you the following items for reconstitution and administration:

- IV Injection supplies:
 - Butterfly needle with at least 7 inches of tubing
 - RUCONEST vials (1 or 2 vials depending upon your dose)
 - 14 mL sterile water for injection (diluent) for each vial of RUCONEST
 - 30 mL sterile syringe
 - Vented vial adapters for each sterile water and vial of RUCONEST
- Administration supplies:
 - Self-releasing tourniquet
 - Tape, sterile gauze, gloves
 - Alcohol wipes for cleaning skin and tops of sterile water vials and RUCONEST vials
- Other useful items:
 - Clock or stopwatch to monitor time
 - Sharps or other disposal container
 - Treatment diary
 - Supply mat, provided by your RPA nurse
- Note: Check the expiration date on all items. Never use any supply or RUCONEST vial after the expiration date stated on the item or if the protective caps are missing.
- RUCONEST can be stored on a shelf to keep at room temperature (59°F - 77°F; no need for refrigeration).

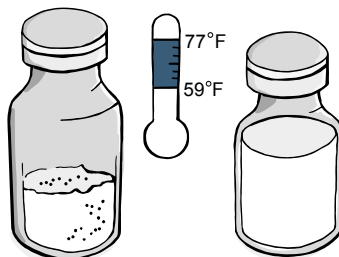

Preparing your solution

1. Cleaning and other requirements

- Before you start, wash your hands carefully.
- Clean the surface to create a sterile surface before opening your supplies and RUCONEST vials.
- Set your supplies on the clean, flat surface (you can use the RPA-supplied place mat that shows you which items you need).

2. Disinfection of vial stoppers

- Remove the plastic flip-off cap from the RUCONEST and sterile water vials.
- Use an alcohol pad to disinfect all vial stoppers and allow them to dry for 30 seconds. Do not blow on the stoppers.
- After disinfection, do not touch the stoppers with your fingers or anything else.

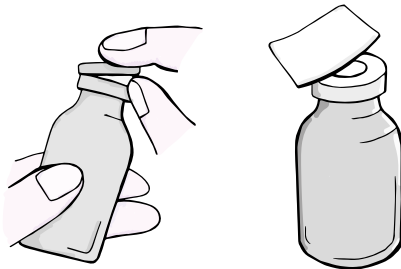

3. Putting the vented vial adapters on vials

- Each RUCONEST vial and sterile water vial needed for your dose will need a vented vial adapter snapped on.
- Take a packaged adapter in one hand and remove the paper lid from the bottom, but keep the adapter in its plastic packaging until you are ready to attach your syringe.
- Remove the vented vial adapter and attach to your RUCONEST vials and sterile water. Once this is completed, you can remove the packaging.
- Depending upon which specialty pharmacy you use, your vented vial adapter could look different from the image below.
- Put the adapter onto a RUCONEST vial, piercing the stopper, until it snaps onto the vial neck.

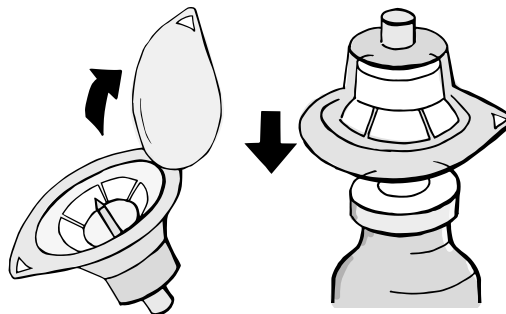

Best Practice: leave on the outer packaging of the vented vial adapters until you are ready to attach your syringe.

4. Drawing up the sterile water

- (A) • Take a sterile syringe out of its packaging.
- Remove the packaging from the adapter on the sterile water vial.
- (B) • Hold the adapter with one hand. With the other hand, attach the syringe and secure by turning it clockwise until it stops.
- (C) • Turn everything – sterile water vial with adapter and syringe – upside down. While keeping it vertical, **slowly** draw in 14 mL of sterile water.
- (D) • Remove the syringe from the adapter by turning counter-clockwise.

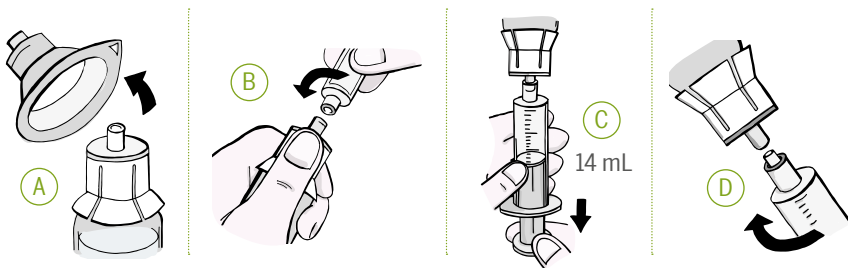

Note: If air bubbles appear, gently tap the syringe and apply gentle pressure by pushing the plunger into the syringe. Continue to fill the syringe with 14 mL of sterile water.

5. Adding sterile water to RUCONEST and dissolving

- (A) • Remove the packaging from the adapter on the RUCONEST vial.
- Take the syringe with sterile water that you prepared in step 4.
- Hold the adapter with the other hand and attach the syringe. Secure the syringe by turning it clockwise until it stops.
- (B) • Push 14 mL of sterile water slowly into the RUCONEST vial in order to minimize foaming.
- (C) • Leave the syringe on the adapter and gently swirl the vial for about 30 seconds. Please do not shake the RUCONEST vial.
- Keep the vial on a flat surface until the solution is clear. If the RUCONEST is not fully dissolved continue to gently swirl the RUCONEST vial.
- Repeat steps 4 and 5 if you need to prepare a second vial.

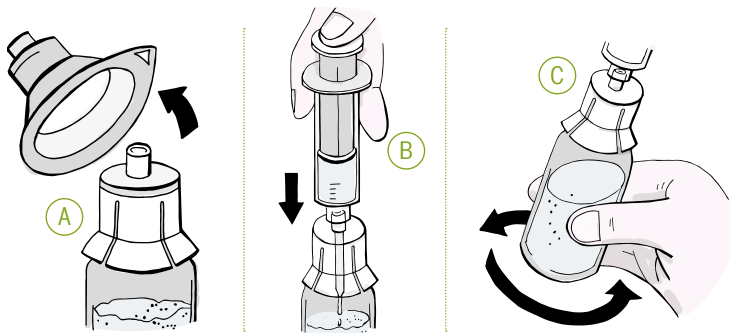

6. Check prepared solutions

- Check whether the RUCONEST in the vial(s) has dissolved completely
- After the RUCONEST has dissolved, the solution should be clear and colorless.
- Do not use the prepared solution if it is cloudy, contains particles, or has changed color. Inform your healthcare professional if this occurs. Small amounts of foam are acceptable.

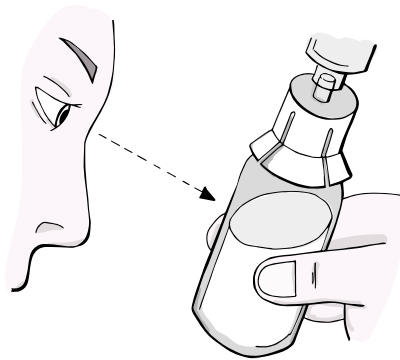

7. Drawing up prepared solution

- Your doctor will tell you how much to inject.
- Draw in the volume of prepared solution, while keeping the syringe in the vertical position. You may need one or two vials depending on the dose prescribed by your doctor. The maximum dose is 4200 U (28 mL).
- Unlock the syringe by turning it counter-clockwise.
- Place the syringe on the work surface, taking care not to touch the surface or any other object with the syringe tip.

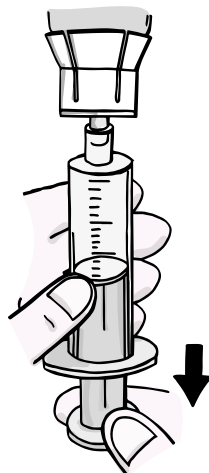

Finding a Vein

1. Required components

Once you have reconstituted RUCONEST and pulled up your appropriate dose into your syringe, you will want to prepare the items needed to easily self-administer RUCONEST.

- Go ahead and prepare tape (1 or 2 strips) to help secure the butterfly needle once inserted.
 - Place a piece of tape gently over the wings of the butterfly needle, so once inserted you can gently press the tape onto your arm, holding the needle in place.
- Open your butterfly needle from its package and remove the screw cap.
- Ensure that there are no air bubbles in your syringe before connecting the syringe to the butterfly needle. To remove any bubbles, gently tap on the syringe.

2. Preparation of the injection set

- To fill the IV Injection tubing, connect the syringe filled with RUCONEST to the IV Injection set tubing and gently push on the syringe plunger to fill the tubing with RUCONEST.
- Check that no air is present in the syringe, tube, or needle.

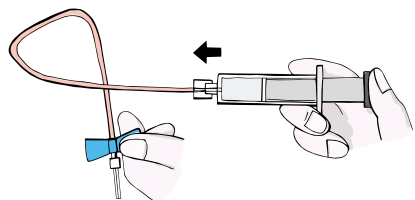

3. Preparing the injection site

- Put your tourniquet on the arm of the vein you would like to access (above the site of IV Injection (over 5 minutes)).
- Once positioned, palpate for veins that are bouncy and in a position you can access.
- Using a vein squeeze ball or squeezing your first together can help bring veins closer to the surface.
- Once you have located an appropriate vein, disinfect the injection site thoroughly with an alcohol pad and let the skin dry. Be sure to not blow on your arm once disinfected, just allow to air dry.

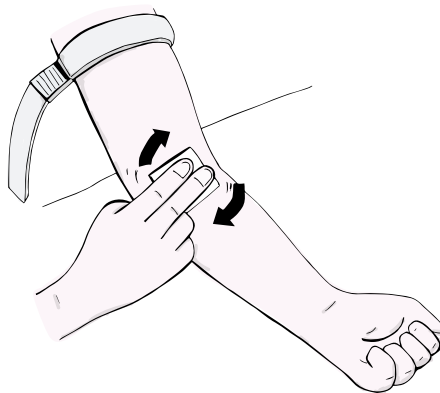

Staying hydrated can help with vein access.

4. Administration of the prepared solution

- Remove the butterfly needle cap.
- Ⓐ • Carefully insert the needle with the bevel facing up, at the flattest possible angle, into the vein. You will know you have appropriately placed the needle in your vein when you see a flashback of blood in the tubing near the needle.
 - Make sure the needle is in a vein.
 - Gently pull back on the syringe plunger and check to see if blood is in the tubing.
 - If there is blood present, then the needle is in a vein.
 - If there is no blood, remove the needle and repeat this step using a new needle, new administration tubing, and a different injection site.
- Secure the needle by applying the tape over the wings of the needle.
- Release the tourniquet.
- Ⓑ • Slowly inject the solution into the vein over 5 minutes.

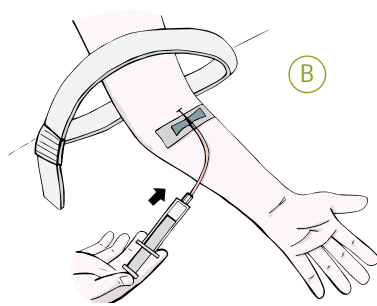
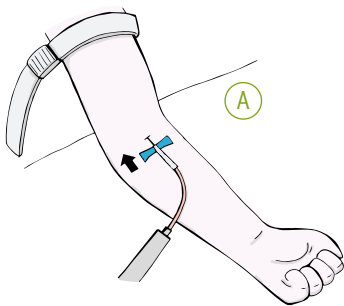

5. After administration

- Carefully remove the needle from the vein and press the sterile gauze on the injection site to stop any bleeding.
- Cover the injection site with a clean bandage.
- Place the protection cap over the needle.
- Dispose of the used IV Injection needle set and any unused solution/vials in a medical waste container according to state laws. If you are unsure ask your healthcare professional.
- Make sure you record the date and time of treatment in your patient diary, including the lot number written on the label of the RUCONEST vial.

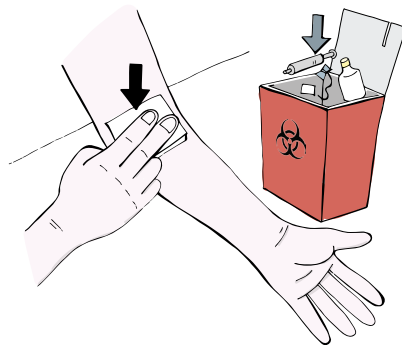

We hope this step-by-step guide was helpful as you reconstituted and administered RUCONEST! Please know you or your family can call your RPA at any time, or RUCONEST SOLUTIONS™ at 1-855-613-4423 any time Monday - Friday 8 am - 8 pm ET.

RUCONEST INDICATIONS (USES)

Ruconest is an injectable medicine that is used to treat acute angioedema attacks in adult and adolescent patients over the age of 12 with Hereditary Angioedema (HAE).

IMPORTANT SAFETY INFORMATION

Do not use RUCONEST if you have experienced life-threatening immediate hypersensitivity reactions, including anaphylaxis, to RUCONEST or to any other C1 esterase inhibitor (C1-INH) product. Call your healthcare professional or the emergency department right away if you experience: wheezing, difficulty breathing, chest tightness, turning blue (look at lips and gums), fast heartbeat, swelling, faintness, rash or hives.

Do not use RUCONEST if you have a known or suspected allergy to rabbits or rabbit-derived products. If you do not have a known rabbit allergy, testing is not required.

Tell your healthcare provider about all your medical conditions, including if you have a known allergy to rabbits. Tell your healthcare provider about any other medications you are taking, as some medications, such as birth control pills and certain androgens, can increase risk of clotting problems. Also tell your healthcare provider if you are pregnant, breastfeeding, or planning to do so.

The most common side effects patients experienced during clinical studies include headache, nausea and diarrhea.

These are not all the possible side effects of RUCONEST.

If any of the side effects get serious, or if you notice any side effects not listed here, please inform your healthcare provider or pharmacist. You can also report side effects to the FDA at 1-800-FDA-1088 or visit www.fda.gov/medwatch.

For product information, adverse event reports, and product complaint reports, please contact Pharming U.S. toll-free:

[\(844\) 474-2764](tel:8444742764) Main corporate number

[\(800\) 930-5221](tel:8009305221) Adverse events, product complaints, medical information

Please read the full Prescribing Information, including Patient Product Information by [clicking here](#).

To learn more about RUCONEST and hear from other patients, follow us on the following social media channels:

